

Composite dry sliding bushings, metric dimensions

Principal dimensions			Basic load ratings		Mass	Designation
d	D	B	dynamic C	static C0	kg	-
mm			kN			
55	60	60	260	815	0,2	PCM 556060 E

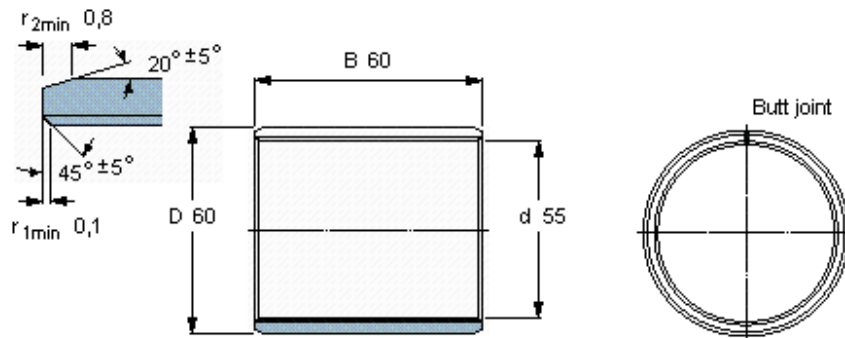

Specific load factor
Material constant

K 80
K_M 480